

PULVERIZA SIN ESFUERZO TU HUERTO Y JARDÍN



Batería Li-Ion

Batería de alto
rendimiento

1 carga =

MAX.
15 x



100-150L
26-40 gal (US)

JARDÍN Y HUERTA

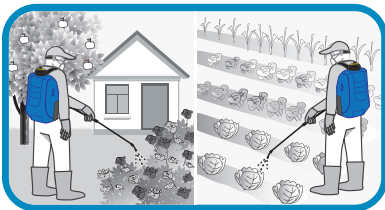

LIGERO Y ERGONÓMICO



BATERÍA DE LITIO RECARGABLE



Manguera reforzada

Asa integrada
y ergonomica

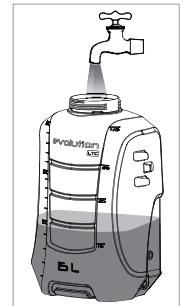

Amplia boca de llenado

Lanza de fibra de
vidrio 0,75 m. (2,46ft)



Correas acolchadas y
ajustables con cierre
en pechera

Boquilla cónica regulable.
Aplicaciones Insecticidas

EXTRA:
Boquilla abanico baja deriva.
Aplicaciones Herbicidas



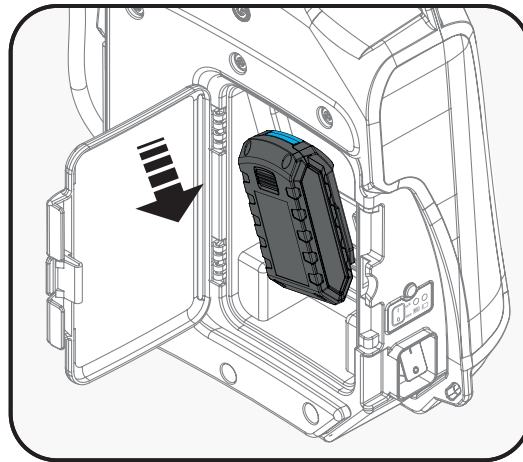

Batería protegida de
facil acceso y reemplazable

* Incluye cargador

MAX.
15 x 
100L-150L
26-40 gal (US)

12V
BATERÍA
Li-Ion

BOQUILLAS INCLUIDAS para diferentes tipos de tratamientos. (Para más opciones de boquillas consultar).

INSECTICIDA/FUNGICIDA

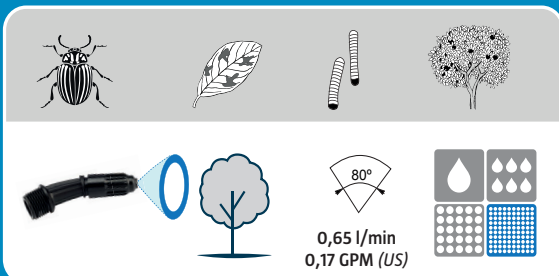

HERBICIDA

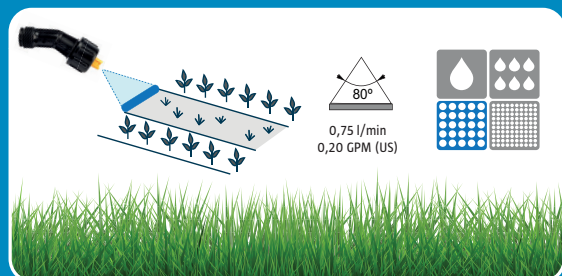

CARACTERÍSTICAS TÉCNICAS

| PESO NETO | CAPACIDAD NOMINAL | PRESIÓN MÁXIMA | BATERÍA (Li-Ion) | TIEMPO CARGA MÁXIMO | AUTONOMÍA LITROS POR CARGA BATERÍA | CÓDIGO |
|------------------|----------------------|-------------------|------------------|---------------------|------------------------------------|---------|
| 3.60 kgs 8lbs | 10 L 2.5 gal (US) | 5,5 bar 80 PSI | 12 V 2.6 Ah | 4h | 100L-150L 26-40 gal (US) | 8.30.49 |

ACCESORIOS OPCIONALES

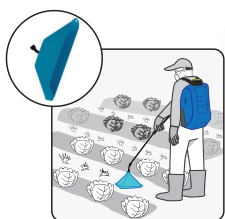

Campana

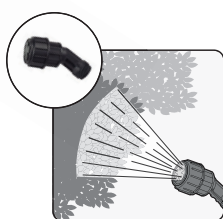

Boquilla 4 orificios

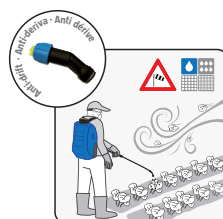

Boquilla aire incluido

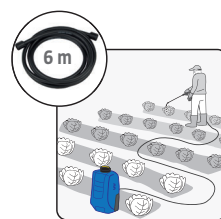

Manguera

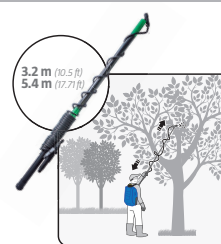

Lanza telescópica

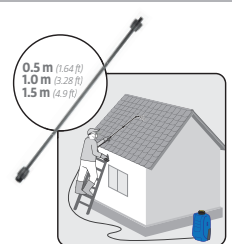

Alargadera